

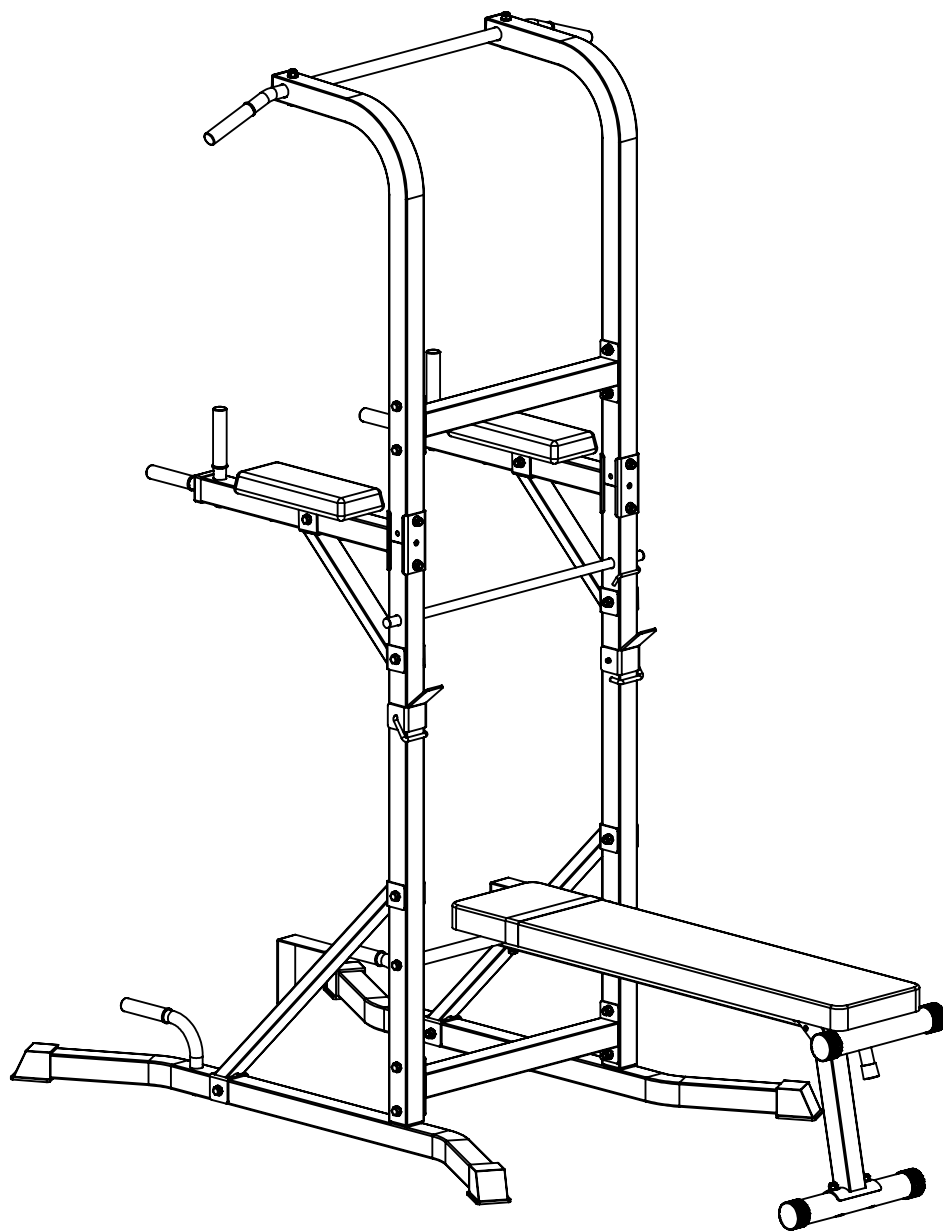











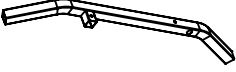

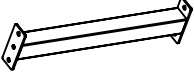

EPSILON

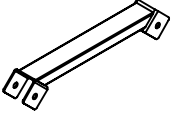
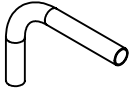

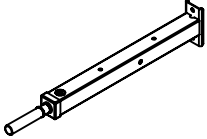

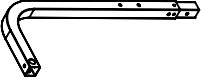

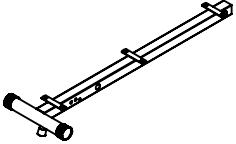
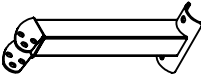
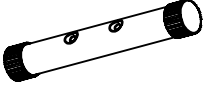
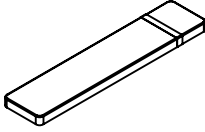
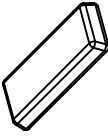

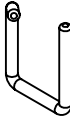
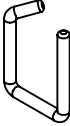
Schedule of

序号	名称	数量	序号	名称	数量
1	At the end of tube - to the left	1	21	Foot set	4
2	At the end of tube - right	1	22	Plastic pipe	1
3	post	2	23	bolt1	1
4	Connecting pipe	2	24	bolt2	1
5	Brace tube	2	25	boltM10X70	20
6	A shaft	1	26	Countersunk head screw	2
7	Safety lever	1	27	boltM10X65	3
8	Small stay tube	2	28	boltM8X70	4
9	push-ups	2	29	boltM10X20	6
10	Put aside frame	2	30	boltM10X30	1
11	Connection piece	2	31	boltM8X20	6
12	boom	2	32	gasket ϕ 10	55
13	handrail	2	33	gasket ϕ 8	10
14	bend	2	34	nut M10	25
15	High drawn tube	1	35	Ring bolt	1
16	Backing bar	1			
17	Before the bracing tube	1			
18	At the end of tube, the former	1			
19	Back cushion	1			
20	Elbow pads	2			

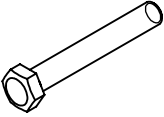
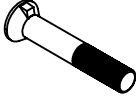
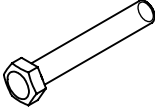
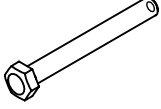
parts1

1  X1	2  X1	3  X2	4  X2
5  X2	6  X1	7  X1	8  X2
9  X2	10  X2	11  X2	12  X2
13  X2	14  X2	15  X1	16  X1
17  X1	18  X1	19  X1	20  X2
21  X4	22  X1	23  X1	24  X1

parts2

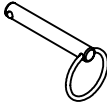
<p>25</p>  <p>M10X70-20</p>	<p>26</p>  <p>M10X65-2</p>	<p>27</p>  <p>M10X65-3</p>	<p>28</p>  <p>M8X70-4</p>
<p>29</p>  <p>M10X20-6</p>	<p>30</p>  <p>M10X30-1</p>	<p>31</p>  <p>M8X20-6</p>	<p>32</p>  <p>ϕ 10-55</p>
<p>33</p>  <p>ϕ 8- 10</p>	<p>34</p>  <p>M10-25</p>	<p>35</p>  <p>X1</p>	

steps-1

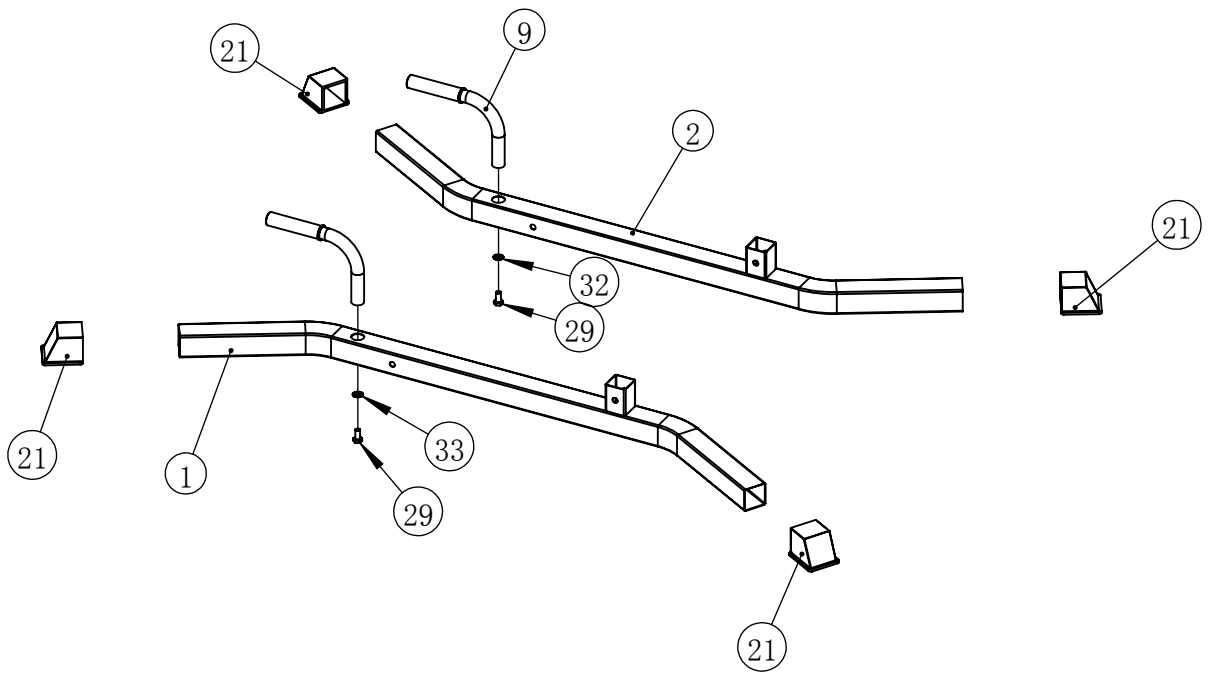

steps-2

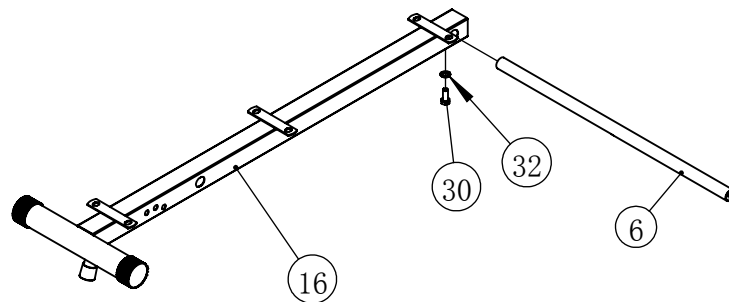

steps-5

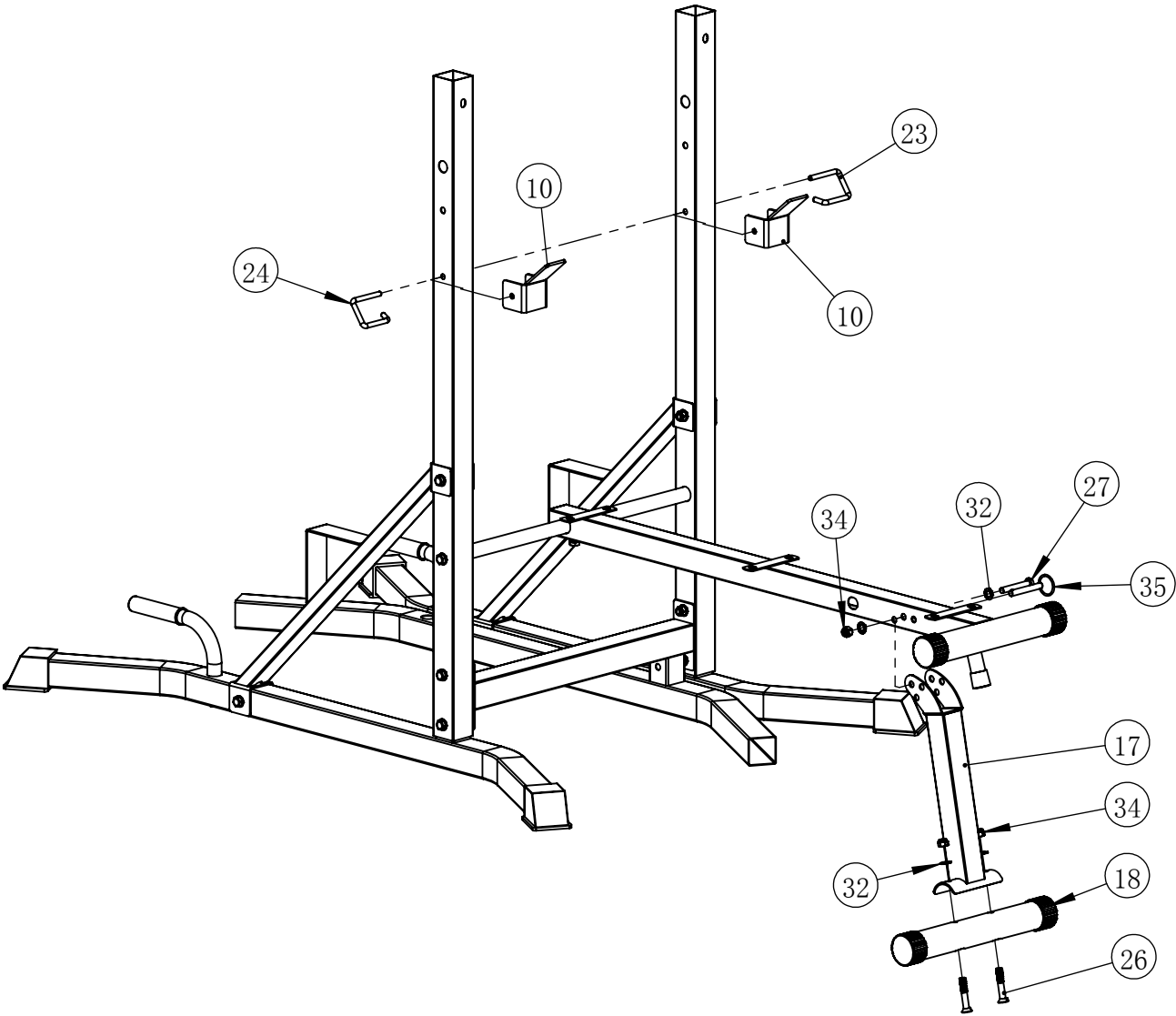

steps-6

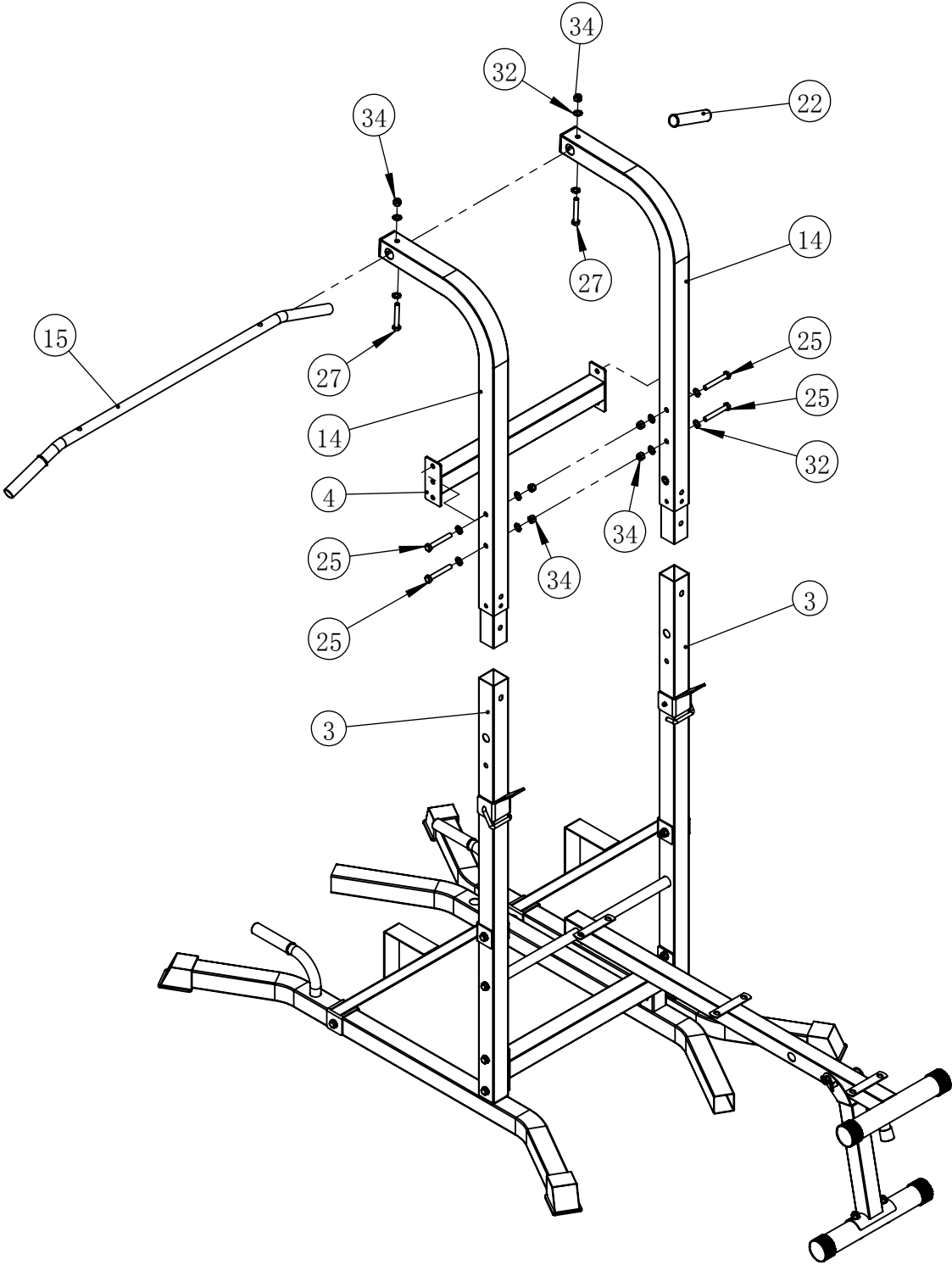

steps-7

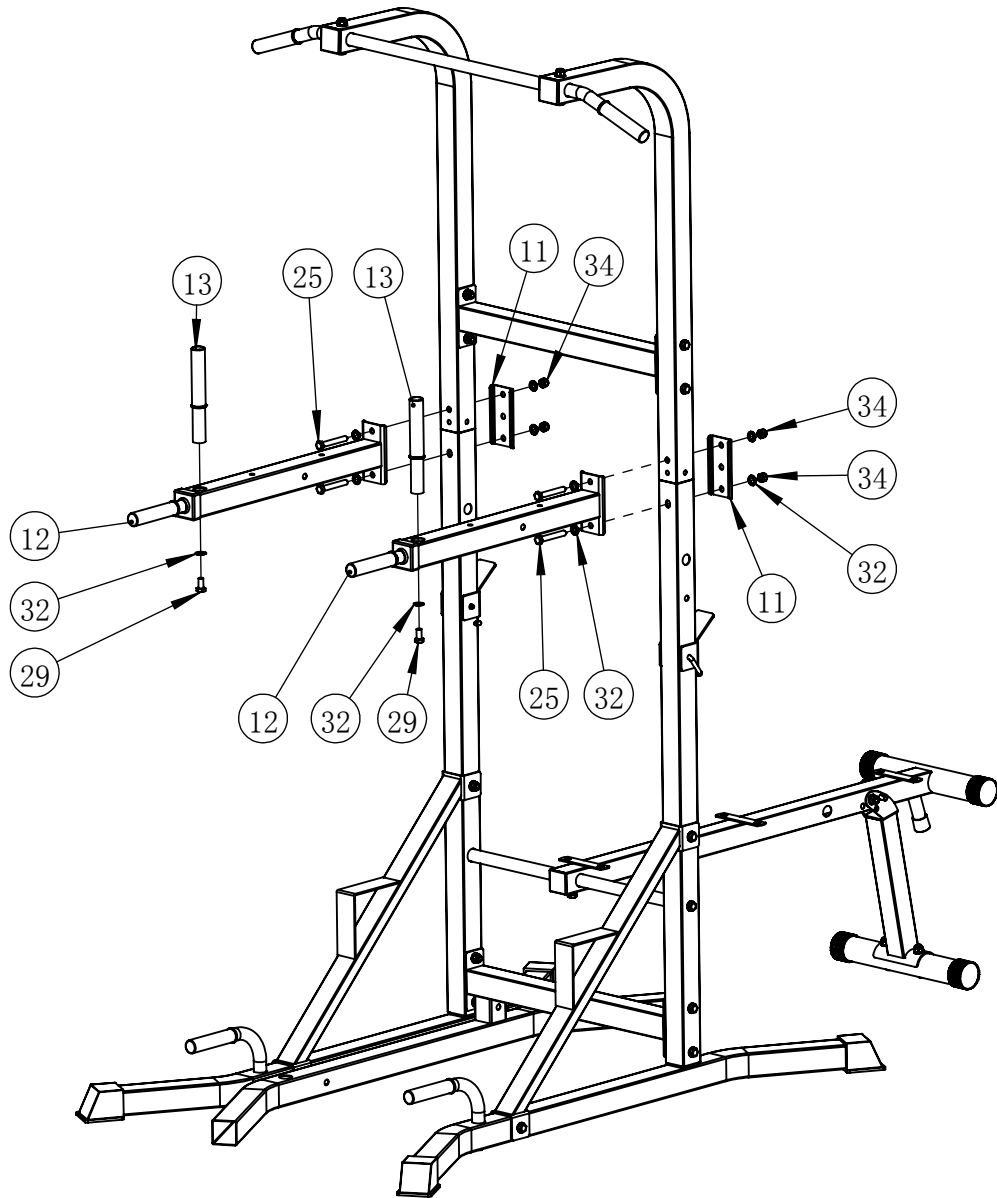

steps-8

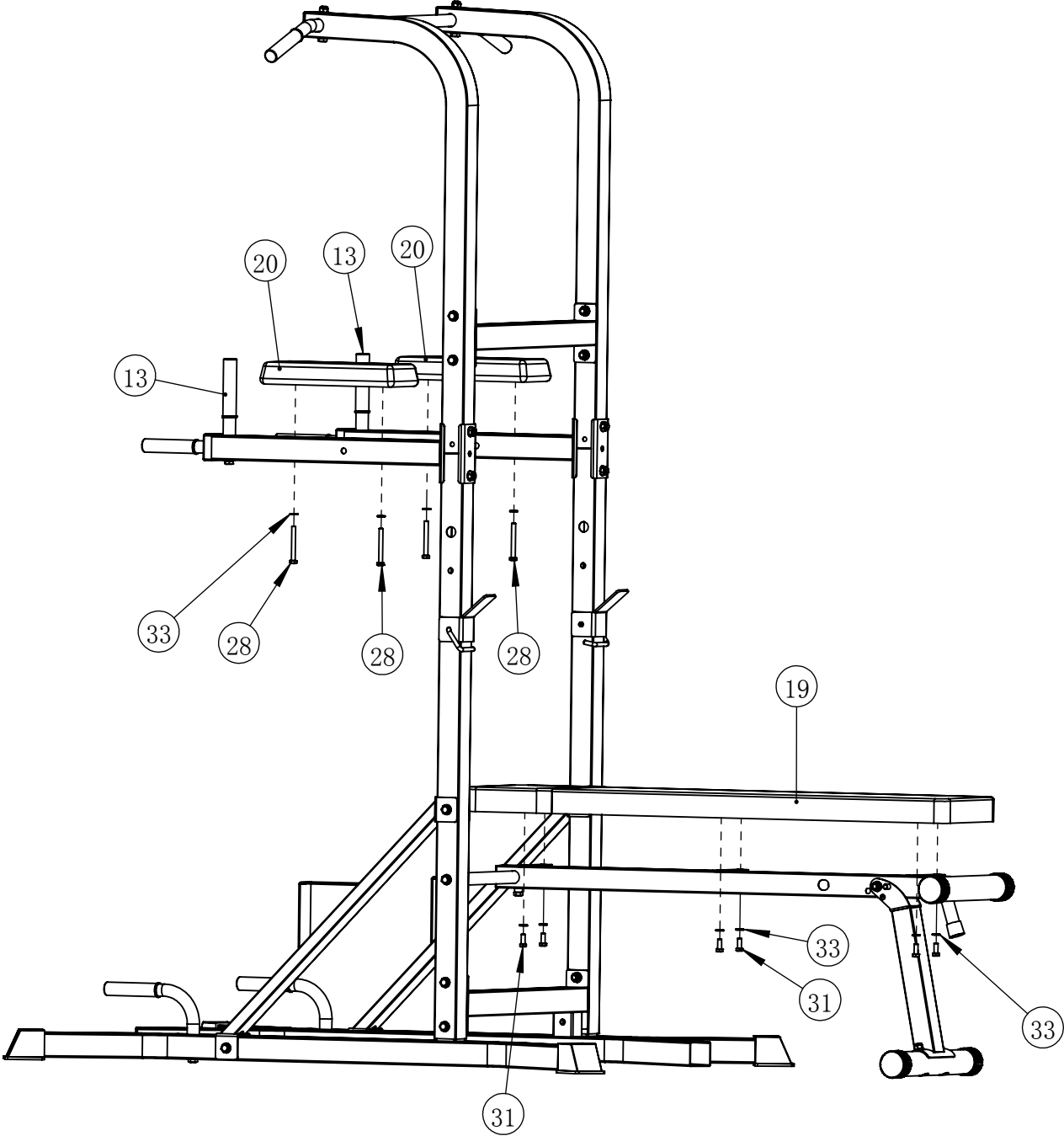

steps-9

